



Interception, Replication, Security & Consolidation Solutions

SDI Toolkit For Sensitive Data Intercept
protects sensitive data-at-rest. Interception,
encryption, and tokenization

FileSync
synchronizes Guardian & OSS files and
programs across NonStop systems

OPTA2000
date & time and time zone simulator

OPTA
interception & trace utilities for NonStop
applications

Enscribe-2-SQL Toolkit
seamless migration to SQL tables for Enscribe
programs

Enscribe-2-SQL Replicator
online replication of Enscribe files to SQL tables

Command Stream Replicator
automatically replicates DDL structure, non-audited
and HP utilities operations to backup system

TMF-Audit Toolkit
seamless migration to TMF audited files for non-TMF
programs

TANDsoft Products

(NonStop X Certified)

SDI Toolkit for Sensitive Data Intercept

Protects sensitive data-at-rest with no application changes.

FileSync

Synchronizes Guardian & OSS files and programs across NonStop systems.

With FileSync Deduplication, only changed data is transmitted.

OPTA2000

Provides date & time and time zone simulation for all NonStop Guardian & OSS applications and data bases. No code changes.

OPTA

OPTA's suite of interception and trace utilities includes Recycle Bin, OPTATrace, EMS Alerts Online Startup and Termination Capture Utility, Low Pin Optimizer and Process Stack monitor.

TANDsoft Products

(NonStop X Certified)

Enscribe-2-SQL Toolkit

Enables seamless migration to SQL tables for Enscribe programs, with no code changes.

E2S-Lite enables efficient, low-cost Enscribe modifications.

Enscribe-2-SQL Replicator

Online replication of Enscribe files to SQL tables, with no code changes.

Command Stream Replicator

Automatically replicates DDL structure, non-audited and HP utilities operations to backup system.

TMF-Audit Toolkit

Enables seamless migration to TMF audited files for non-TMF programs, with no code changes.

SDI Toolkit

Sensitive Data Intercept

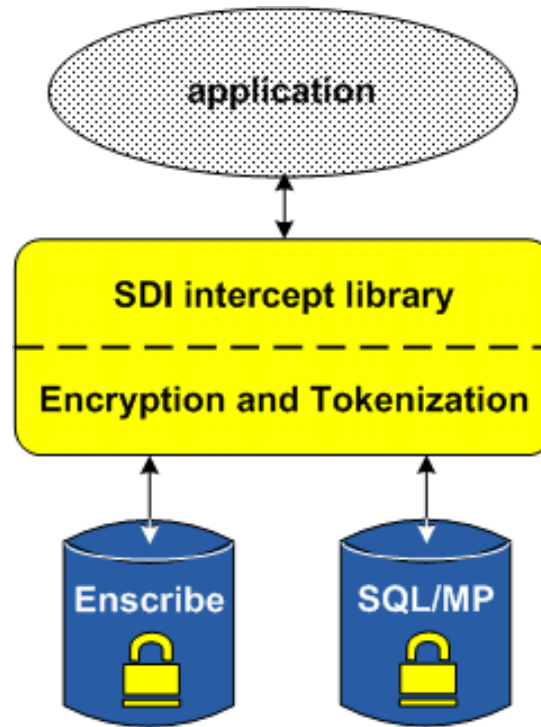

Protects Sensitive Data at Rest

SDI Toolkit

Sensitive Data Intercept

Features

- Protects sensitive data-at-rest for NonStop applications.
- Intercepts NonStop database access calls, encrypting data written to disk and decrypting data read from disk.
- Combined with HP partner security solutions, with HP Security Voltage, or with in-house security solutions, SDI Toolkit offers additional encryption and tokenization capabilities.
- Supports NonStop Enscribe and SQL/MP, native and non-native applications. *SQL/MX support coming soon.*
- No application changes are required.
- Helps organizations to remain compliant with industry regulations such as PCI-DSS, HIPAA, SOX.

FileSync

Replication & Synchronization Software

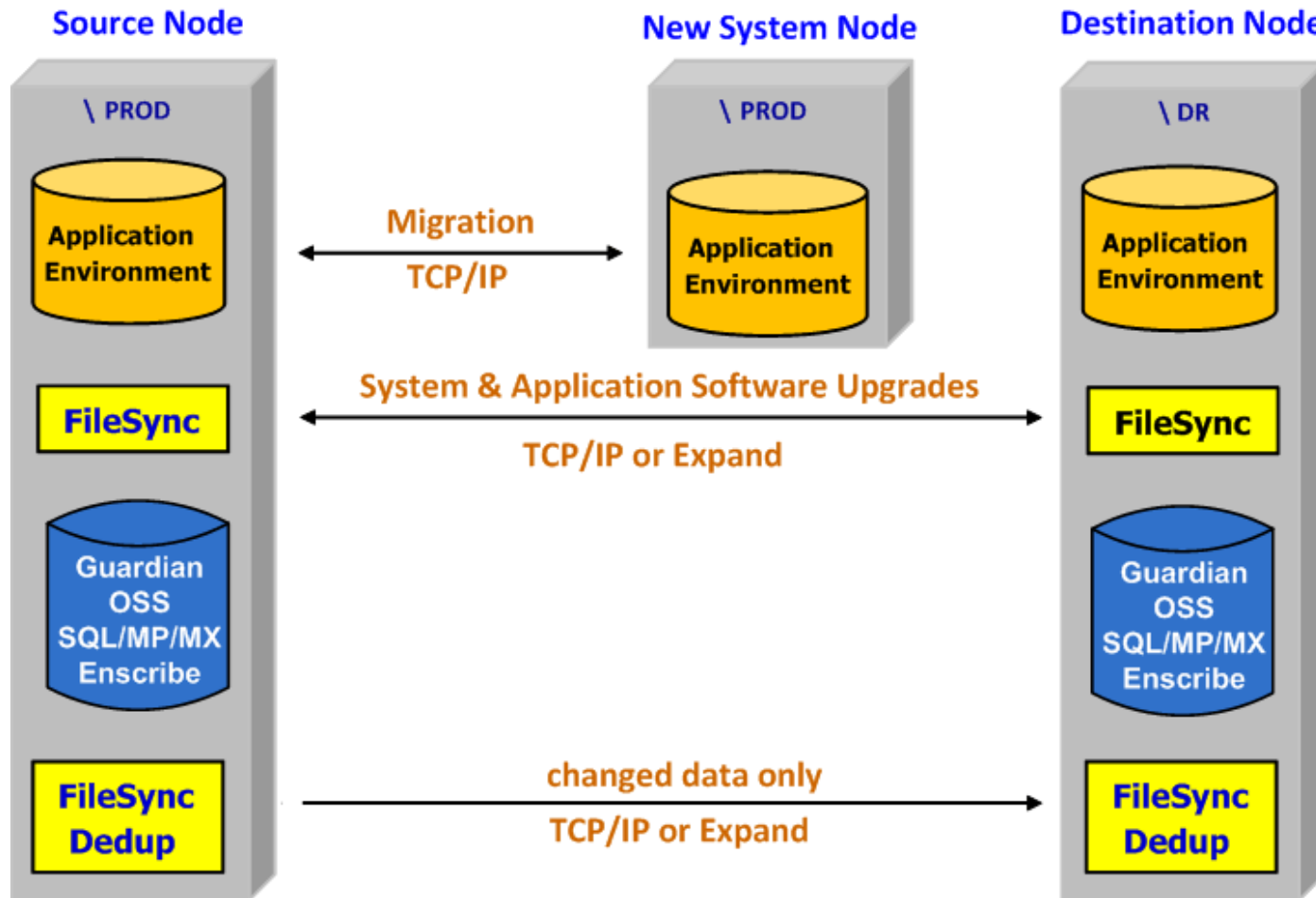

FileSync

Replication & Synchronization Software

FileSync

Automatically monitors, replicates and synchronizes non-database files and application environments. Use for disaster recovery, migrations, upgrades, and backups. Supports a wide variety of file types.

FileSync Data Deduplication

Significantly reduces bandwidth requirements and the size of backups by transmitting only data that has changed within a file or database.

FileSync

Replication & Synchronization Software

FileSync Incremental

Minimizes the time by synchronizing only files that have changed or are new since the last incremental synchronization.

FileSync AppendOnly

Works with very large, unaudited Guardian and OSS files that must be synchronized every few minutes. Changes made to a file are “appended” to the end of the file. When AppendOnly checks for changes since the last synchronization, it needs only to look at the end of the last changed data update.

FileSync

Features

- Supports Expand and TCP/IP.
- Netbatch and FileSync scheduling capability.
- Supports Enscribe and OSS files. Also supports SQL/MP and SQL/MX objects.
- Automatic or scheduled file synchronization between Guardian and OSS.
- Uses TCP/IP to migrate systems. Synchronize files to new system with same node name.
- Incorporates fault tolerance, parallel processing, qualified file wildcarding, and SQL/MX filters.
- Additional options – Security, Purge, Reporting, Triggers.
- Complements NonStop data-replication products.

FileSync Data Deduplication

Overview

- Takes place at the system hosting the primary database.
- Only changed data, not entire files, are sent to the backup database.
- Reduces backup sizes, reduces bandwidth requirements.
- Decreases disk loads.
- Increases RPO, reduces RTO.

OPTA2000

Time-Zone and Clock Simulator

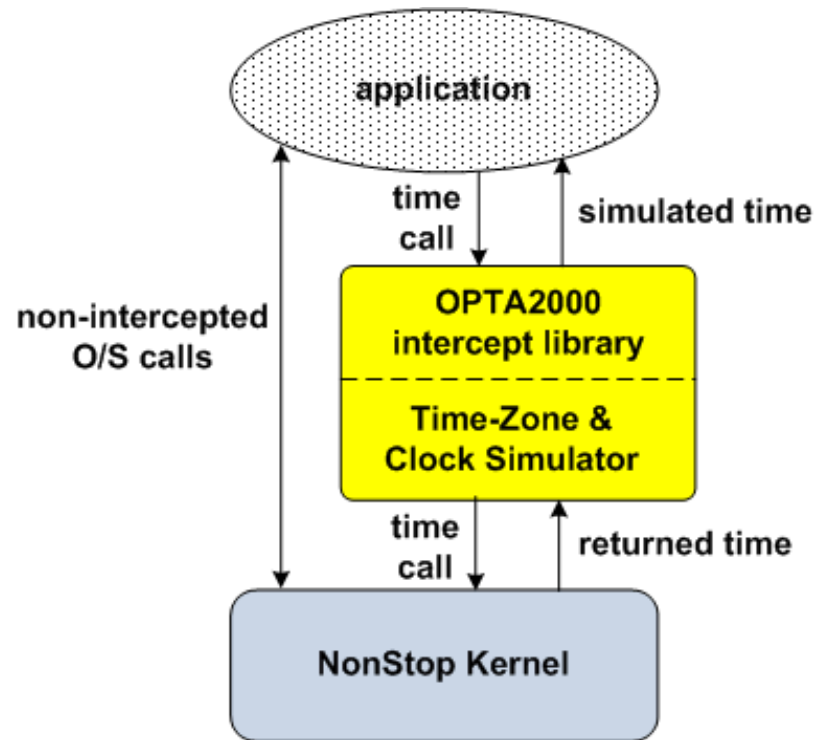

***One system clock. Multiple current times. Multiple time zones.
No Problem!***

OPTA2000

Time-Zone and Clock Simulator

Time-Zone Simulation

OPTA2000 uses intercept libraries and virtual time zone containers to provide simulated time zones to applications and data bases. Time zone simulation allows applications to operate in any virtual time zone. With the ongoing consolidation of data centers, OPTA2000 allows applications to operate in local date and time, independent of the current physical location or time zone of their data center.

One system clock. Multiple current times. Multiple time zones.
No Problem!

OPTA2000

Time-Zone and Clock Simulator

Clock Simulation

OPTA2000 uses intercept libraries and virtual time containers to provide simulated dates & times to applications and data bases. Date and time simulation allows organizations to "time travel" their applications in the future or past to test all date & time sensitive logic. OPTA2000 eliminates the need to change system clocks for time-sensitive testing. Remember Y2K?

*One system clock. Multiple current times. Multiple time zones.
No Problem!*

OPTA2000 Features

Supports All NonStop Guardian and OSS Applications

- No code changes and no system clock changes.
- Date & time simulation allows organizations to "time travel" their applications in the future or past to test all date & time sensitive logic.
- Time zone simulation allows applications to operate in any virtual time zone. With the ongoing consolidation of data centers, OPTA2000 allows applications to operate in local date and time, independent of the current physical location or time zone of their data center. Multiple virtual time zones on one NonStop server.
- Supports major third-party applications.
- Supports Daylight Saving Time (DST) transitions.
- Does not interfere with other applications on the same system.
- Ideal for customers consolidating servers onto Blades or Integrity NonStop X.

OPTA

Suite of interception and trace utilities for customizing NonStop applications

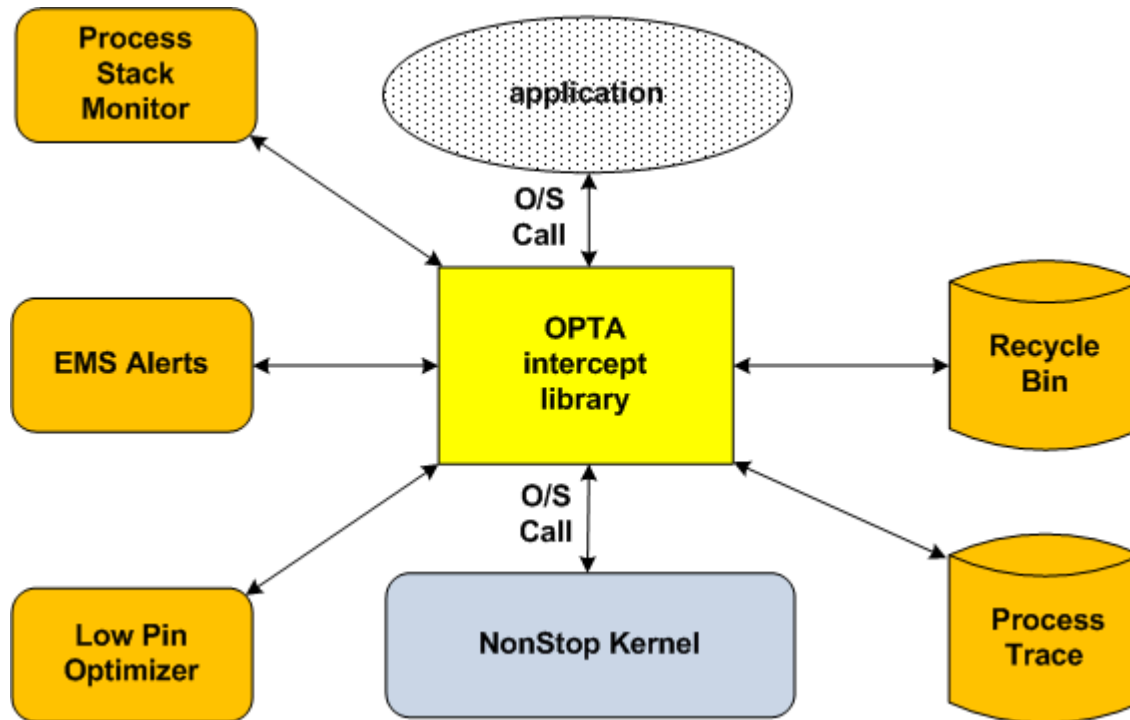

OPTA

Overview

- Online process tracer and analyzer for intercepting NSK system calls.
- With the OPTA API, custom code can easily extend application capabilities.
- Supports all HP NonStop application types and platforms.
- Reduces development, testing, and support costs.
- No application code changes are required.

OPTA

Features

- ***Process Stack Monitor*** analyzes an application's stack usage and reduces stack overflows.
- ***OPTA-Trace Online Process Tracer and Analyzer*** seamlessly intercepts and traces procedure calls made to the NonStop Kernel operating system.
- ***Recycle Bin*** provides fast file retrieval. Purged files are stored in Recycle Bin until you decide to restore them or to delete them permanently.
- ***Low Pin Optimizer*** automatically redirects and balances low-PIN process creation across a server's CPUs to ensure efficient allocation.
- ***EMS Alerts Online Startup and Termination Capture Utility*** traces an application's startup and termination calls via EMS messages.

Enscribe-2-SQL Toolkit

Affordable, Flexible, High Performance

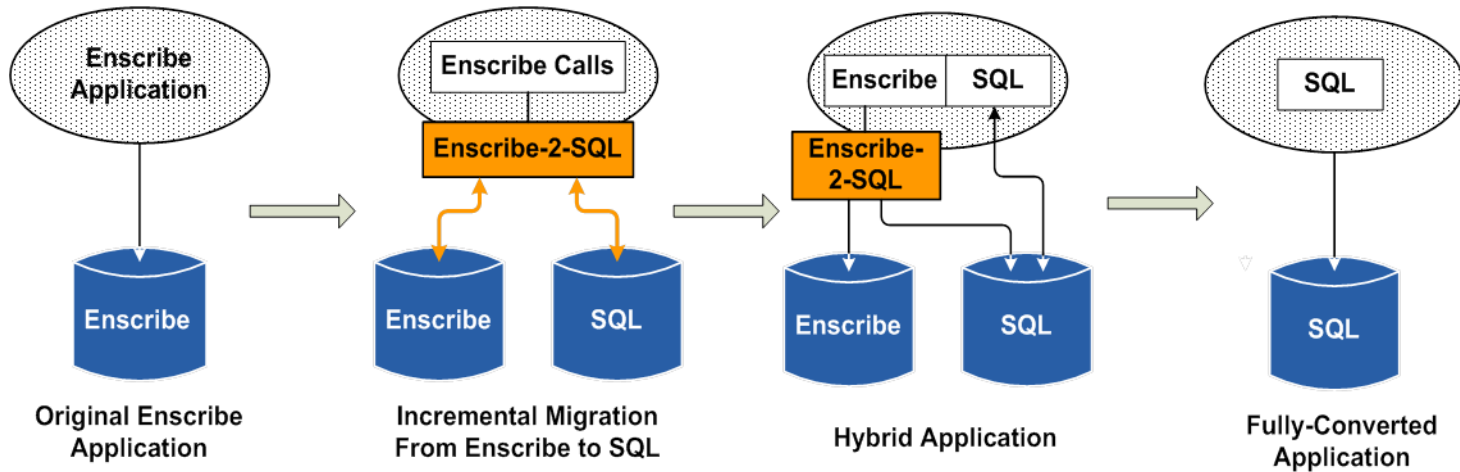

Migrating from Enscribe to SQL with the Enscribe-2-SQL Toolkit

Enscribe-2-SQL Toolkit

Overview

- Offers a flexible, affordable alternative to more expensive conversion products or manual conversion techniques.
- Supports SQL/MP and SQL/MX.
- No changes to the Enscribe applications are necessary.
- Full conversion flexibility otherwise available only with manual conversion is retained.
- *E2S-Lite* enables efficient, low-cost Enscribe modifications.

Enscribe-2-SQL Toolkit

Features

- Available on all HP NonStop servers.
- Offers unlimited conversion flexibility.
- Automatically generates equivalent dynamic SQL/MP statements to access the SQL database.
- Custom SQL statements can be coded with the toolkit API for complex operations and maximum performance.
- No privileged code required.
- Supports full Enscribe API.
- Supports both static and dynamic SQL.

Enscribe-2-SQL Replicator

Online replication of Enscribe files to SQL tables

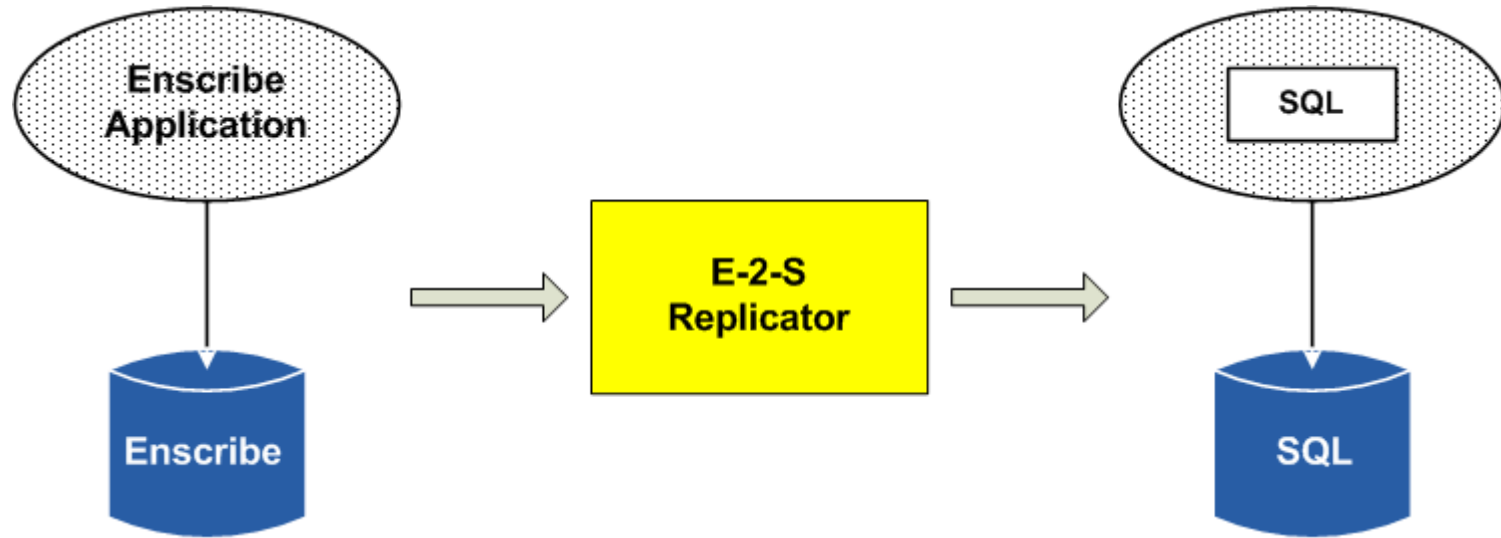

Modernizes legacy Enscribe files to duplicate SQL databases. For Enscribe to SQL migration, SQL/MP databases can be loaded while the Enscribe files are being updated.

E2S-Lite

Enables Efficient, Low-Cost Enscribe Modifications

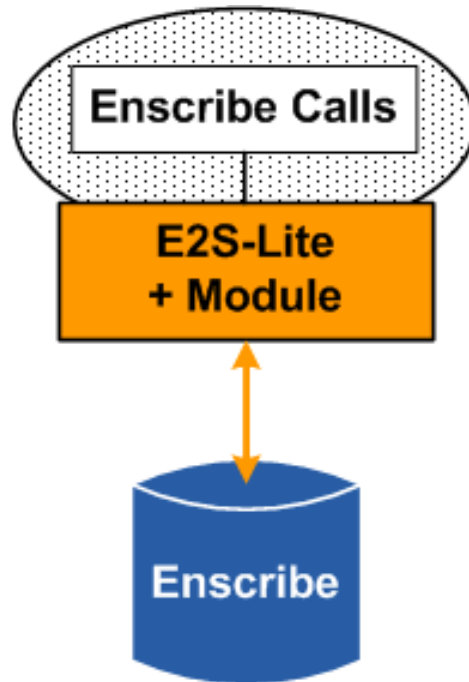

**E2S-Lite Enables Efficient,
Low Cost Enscribe Modifications**

Command Stream Replicator

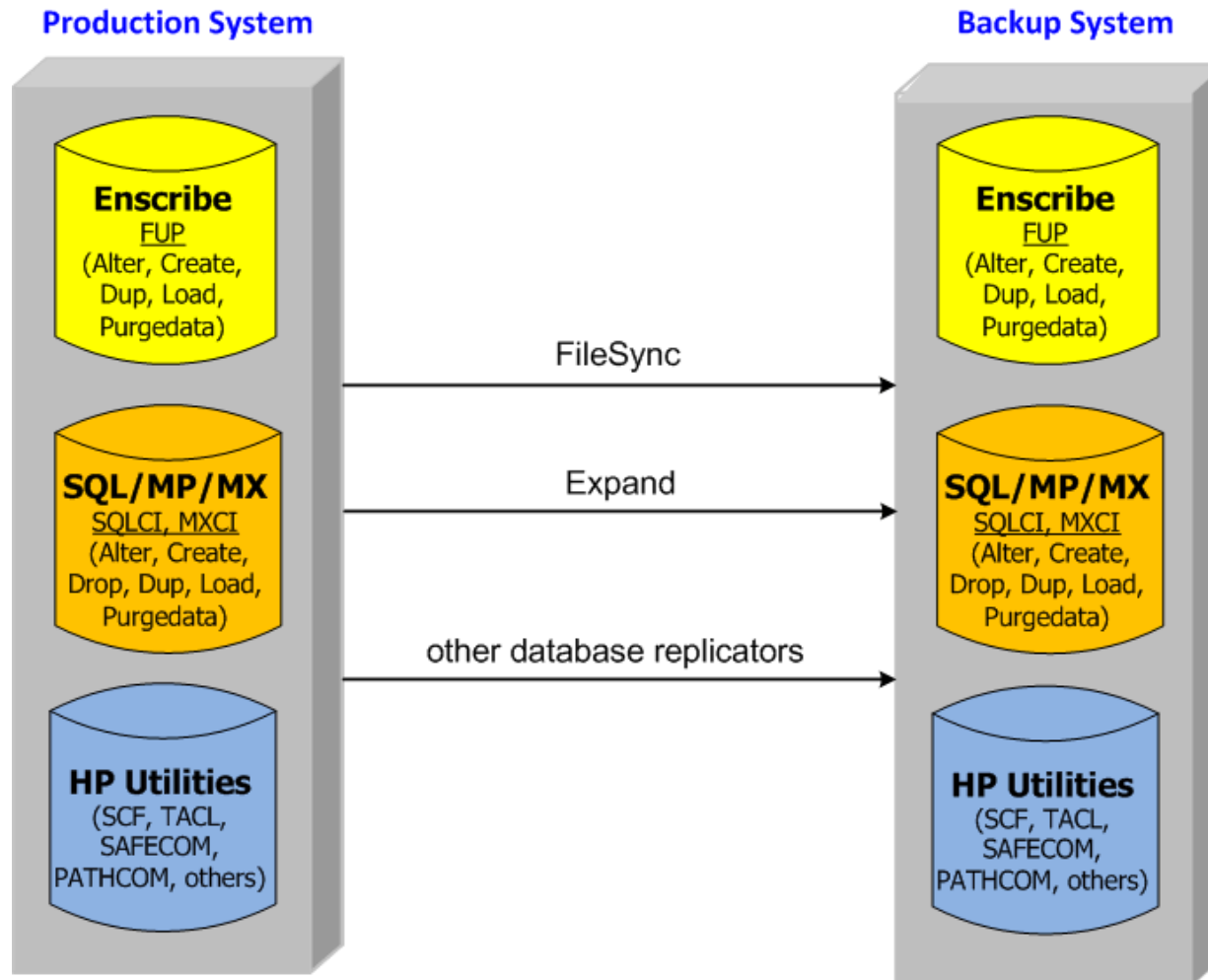

Command Stream Replicator

Overview

- Provides automatic replication of NonStop DDL operations to the backup database.
- Eliminates manual operator intervention for DDL changes on the backup system.
- Provides replication of HP utility (FUP, SQLCI, MXCI, SCF, TACL, SAFECOM, PATHCOM, others) operations to the backup system.

Command Stream Replicator

Features

- Replicates NonStop DDL (SQL/MP, SQL/MX, Enscribe) operations that are not replicated by RDF and other database replicators.
- Replicates file-label, non-audited, and HP utility (FUP, SQLCI, MXCI, SCF, TACL, SAFECOM, PATHCOM, others) operations to the backup system.
- Increases NonStop database availability.
- Can be used with all NonStop data-replication products.

TMF-Audit Toolkit

Easy conversion of non-audited TMF files to audited TMF files

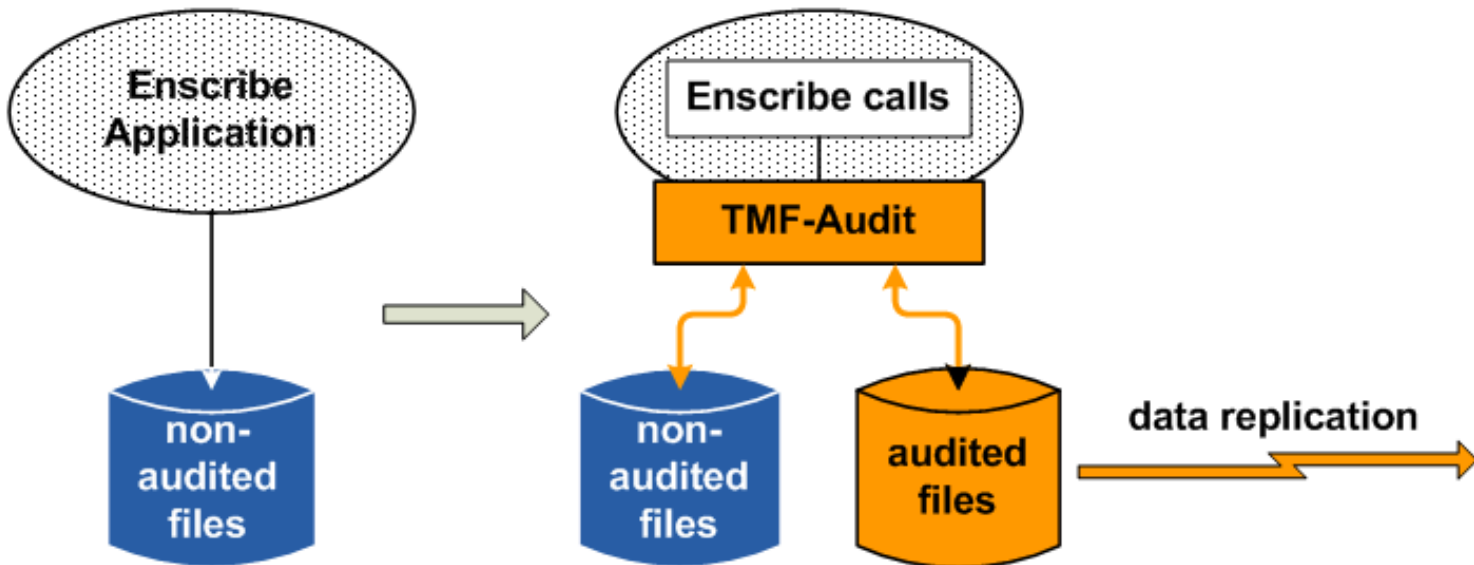

TMF-Audit Toolkit

Overview

- Offers a flexible, affordable alternative to more expensive conversion products or manual conversion techniques.
- Toolkit library includes an API that enables developers to write procedures specifying the TMF transaction boundary.
- No changes to Enscribe applications are necessary.
- Full conversion flexibility otherwise available only with manual conversion is retained.

TMF-Audit Toolkit

Features

- Available on all HP NonStop servers.
- Supports full Enscribe API.
- Permits file-by-file incremental migration and application-by-application incremental migration.
- No privileged code required.
- Online backups for 24x7 availability.
- Improved application database performance.
- Enables replication with RDF, Shadowbase, DRNet, GoldenGate, etc.

Thanks for Watching

Any Questions?

Ask them now, or contact me later at
jack.digiacom@tandsoft.com

